

### SPECIFICATIONS



#### Features

- Max Flow Rate : 1.2GPM(4.5L/Min) @ 60 PSI
- Fits 2 Hole
- Fits 4" Center Holes
- Polished Chrome
- ADA

#### Components





- Metal Lever Handles
- Finished Metal Body
- W/O Pop-Up Drain
- Washerless Cartridge
- Lead Free\* Polymer Lined Waterways
- Water Saving Aerator

#### Drain Type

PPOP5050 – Push Style 50:50 Pop-up W/Overflow (Optional)

### ES241-CP





#### Standards & Certifications

			
✓	✓	✓	✓

#### Available Finishes

			
✓			

#### Mount Type

			
	✓		

Specified model meets or exceeds the following:

- ASME A112.18.1/CSA B125.1
- IAPMO/cUPC
- NSF/ANSI 372
- NSF/ANSI/CAN 61 – Sec. 9: Q≤21
- ADA
- \* ≤ .25% Pb

#### AVAILABLE MODELS

ES241- PUCP – Lavatory Faucet

Mainline products have been manufactured under the highest standards of quality and workmanship. That is why we offer a "Limited 5 Year" warranty on the function and finish of our faucets.



Please visit [www.mainlinecollection.ca](http://www.mainlinecollection.ca) for available finishes. Finish is defined by additional suffix.

#### Drawings

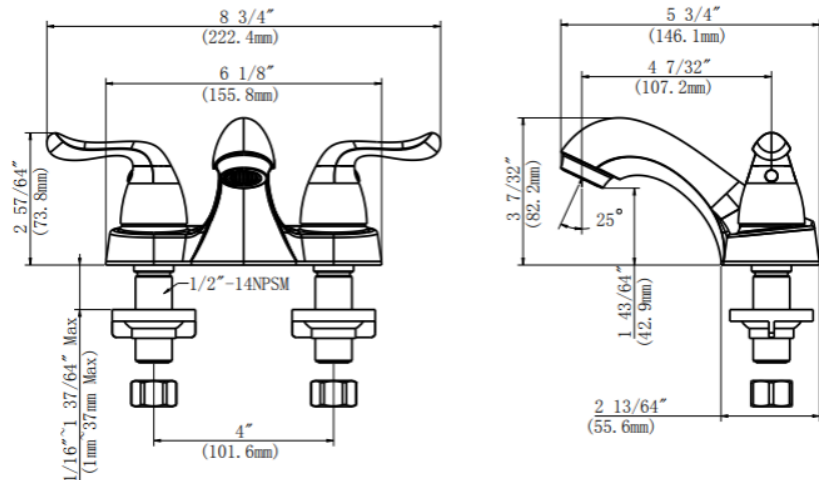

### SUBMITTAL INFORMATION

Name: \_\_\_\_\_ Contractor: \_\_\_\_\_  
 Location: \_\_\_\_\_ Contact #: \_\_\_\_\_  
 Notes: \_\_\_\_\_

#### Service & Parts

Please reach out to [epleservice@emcoltd.com](mailto:epleservice@emcoltd.com) for support/ visit [mainlinecollection.ca](http://mainlinecollection.ca) / CANADA +1 (450) 621 5636