

### SPECIFICATIONS



#### Features

- Max Flow Rate : 2.2 GPM(8.3L.Min) @ 60 PSI
- 1/2" NPT/Sweat Connections
- 4" Centers to Fit Sink Edge or Top Mount
- Rough Brass

#### Components





- Metal Lever Handles/Polished Chrome
- Rough Brass Metal Body
- Hot & Cold Cartridge
- Lead Free\*

#### Drain Type





N/A

ES4093





#### Standards & Certifications

			
	✓	✓	✓

#### Available Finishes

			
✓			

#### Mount Type

Specified model meets or exceeds the following:

- ASME A112.18.1/CSA B125.1
- IAPMO/cUPC
- ADA
- \* ≤ .25% Pb

#### AVAILABLE MODELS

Mainline products have been manufactured under the highest standards of quality and workmanship. That is why we offer a "Limited 5 Year" warranty on the function and finish of our faucets.



Please visit [www.mainlinecollection.ca](http://www.mainlinecollection.ca) for available finishes. Finish is defined by additional suffix.

#### Drawings

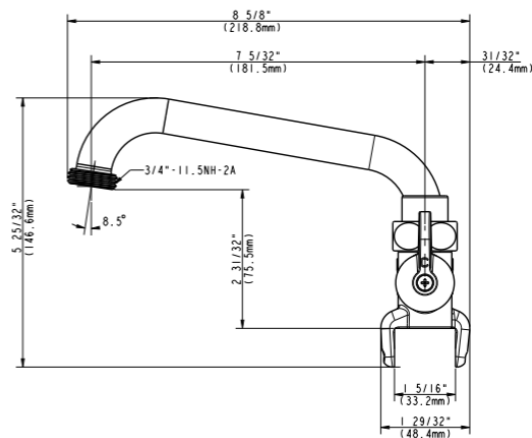
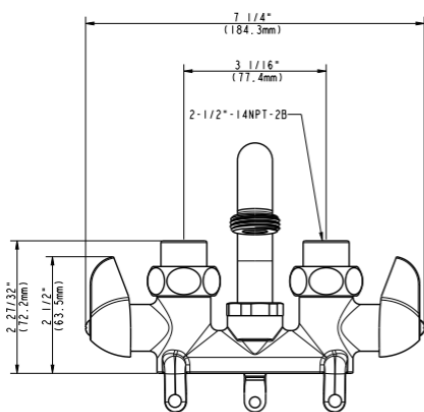

### SUBMITTAL INFORMATION

Name: \_\_\_\_\_ Contractor: \_\_\_\_\_  
 Location: \_\_\_\_\_ Contact #: \_\_\_\_\_  
 Notes: \_\_\_\_\_

#### Service & Parts

Please reach out to [epleservice@emcoltd.com](mailto:epleservice@emcoltd.com) for support/ visit [mainlinecollection.ca](http://mainlinecollection.ca) / CANADA +1 (450) 621 5636