

SPECIFICATIONS



VB211D-PU

Features

- Max Flow Rate : 1.0GPM(3.8L/Min) @ 60 PSI
- Fits Single Hole
- Fits 3 Hole with Deck Plate(Included)
- Available Finishes
 - Polished Chrome(CP)
 - Brushed Nickel(BN)
 - Matte Black(BLM)
- ADA





Drain Type

- MLPOP55 – Push Style 50:50 Pop-up W/Overflow (Included)
- MLPU4T - Push Style Brass Pop-up W/O Overflow (Optional)
- MLPUWO - Push Style Brass Pop-up W/Overflow (Optional)

Components

- Metal Lever Handle
- Finished Metal Body
- Ceramic Disc Cartridge
- W/ Push Pop-up Drain Assembly
- W/4" Deck Plate
- Lead Free* Polymer Waterways
- Water Saving Aerator





Standards & Certifications

			
✓	✓	✓	✓

Available Finishes

			
✓			✓

Mount Type

			
✓	✓		

Specified model meets or exceeds the following:

- ASME A112.18.1/CSA B125.1
- IAPMO/cUPC
- NSF/ANSI 372
- NSF/ANSI/CAN 61 – Sec. 9: Q≤1
- ADA
- *≤ .25% Pb

AVAILABLE MODELS

- VB211-PU – Faucet W/ Pop-Up
- VB211 – Faucet Alone

Mainline products have been manufactured under the highest standards of quality and workmanship. That is why we offer "Limited Lifetime" warranty on the function and finish of our faucets.



Please visit www.mainlinecollection.ca for available finishes. Finish is defined by additional suffix.

Drawings

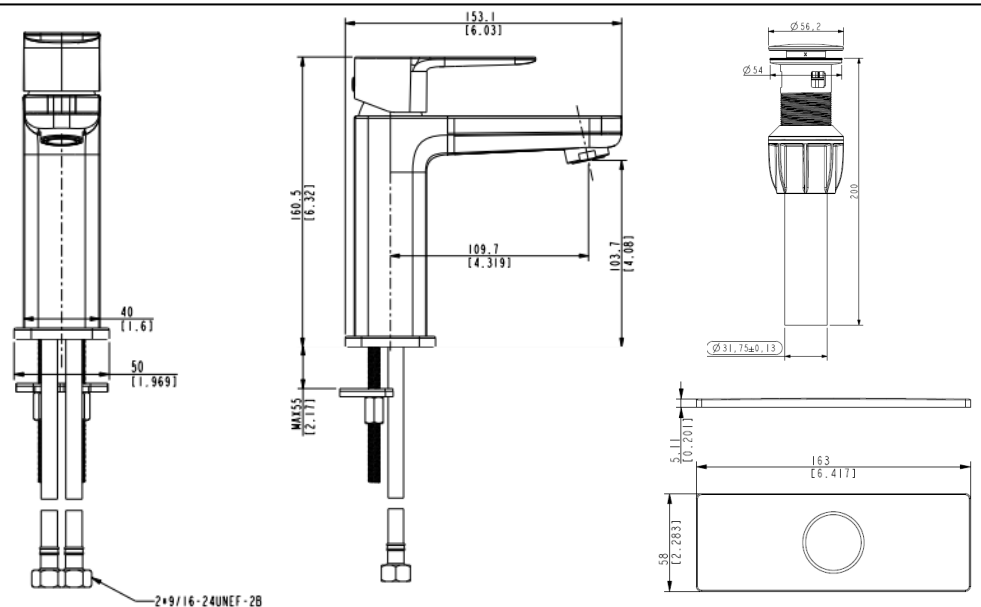

SUBMITTAL INFORMATION

Name: _____ Contractor: _____
 Location: _____ Contact #: _____
 Notes: _____

Service & Parts

Please reach out to epleservice@emcoltd.com for support/ visit mainlinecollection.ca / CANADA +1 (450) 621 5636