

Model/Modèle
BL137
BL137D

Installation / Installation

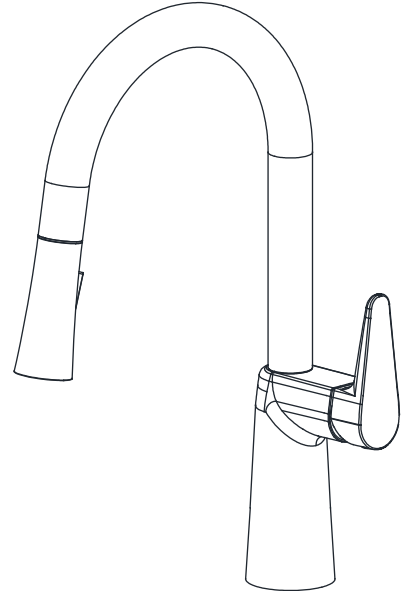

Pull-down Kitchen Faucet Robinet de cuisine a bec arroseur

Tools You Will Need / Outils dont vous aurez besoin



Adjustable Wrench

Clé à molette

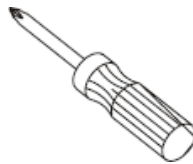

Phillips Screwdriver

Tournevis cruciforme



Silicone Sealant

Enduit d'étanchéité au silicone

INSTALLATION TIPS

- The manufacturer suggests using a locally licensed plumber for installation.
- Cover your drain to avoid losing parts.

CONSIGNES DE INSTALLATION

- Le fabricant suggère de confier l'installation à un plombier qualifié pour exercer dans cette région.
- Couvrir le drain pour ne pas perdre des pièces.



Revised 11/13/2018

Model/Modèle
BL137
BL137D

Installation / Installation

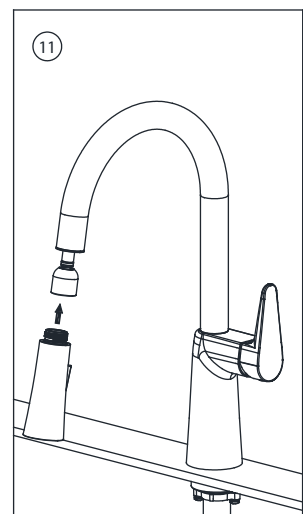
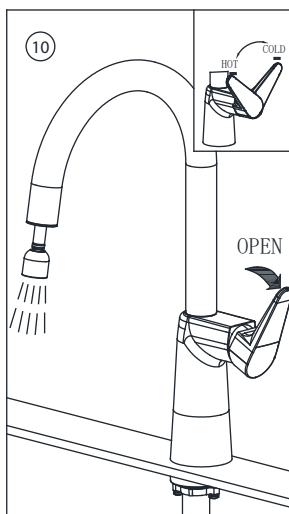
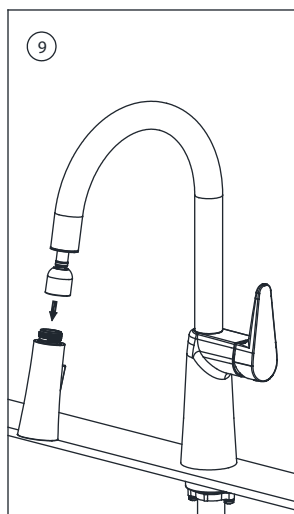
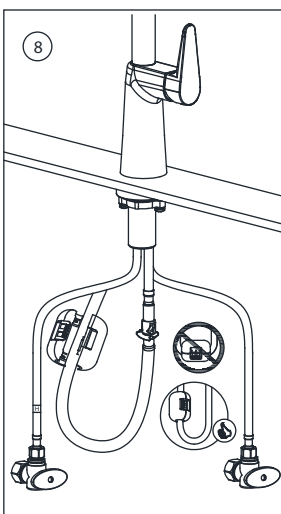
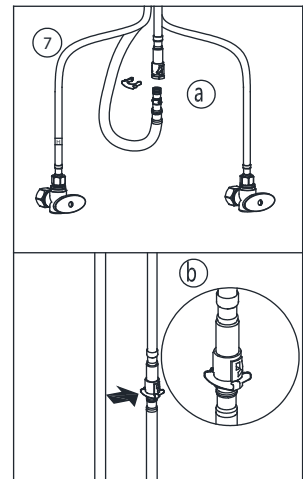
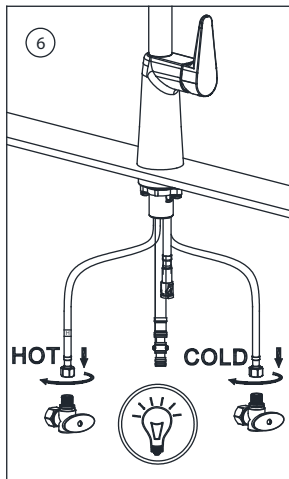
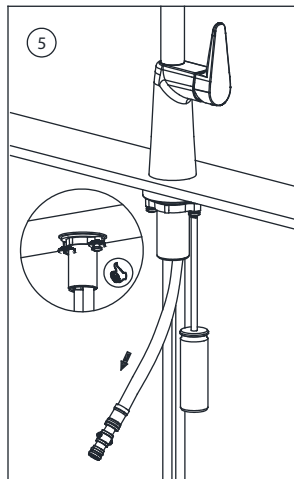
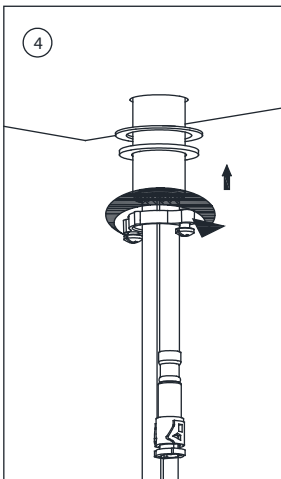
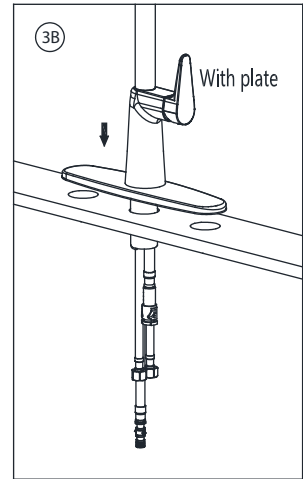
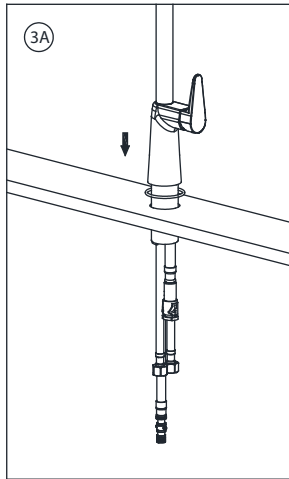
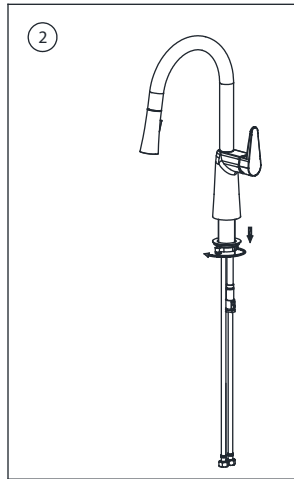
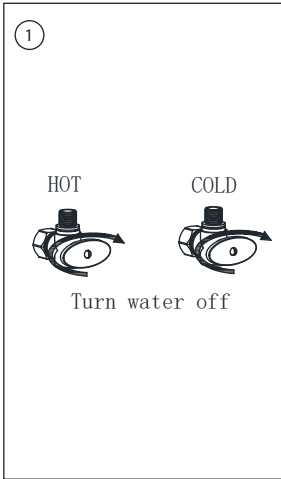

**Model/Modèle
BL137
BL137D**

Installation / Installation

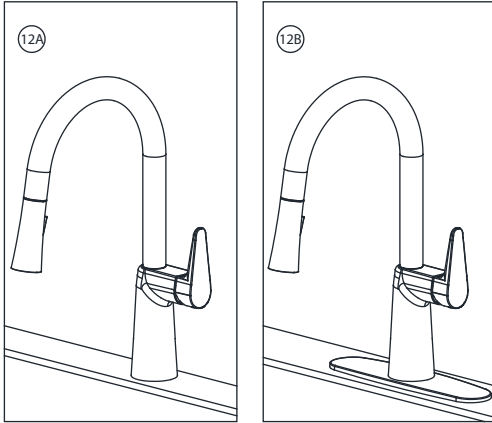

Troubleshooting / Dépannage

If you've followed the instructions carefully and your faucet still does not work properly, take these corrective steps.

Si vous avez suivi attentivement les instructions et que votre robinet ne fonctionne toujours pas correctement, apporter les correctifs suivants.

Problem / Problème / Problema	Cause / Cause / Causa	Action / Correctif / Solución
Leaks underneath handle.	Retainer nut has come loose. O-ring is dirty or damaged.	Tighten the retainer nut. Clean or replace O-ring.
Fuites sous la poignée.	L'écrou de fixation s'est desserré. Le joint torique est sale ou endommagé	Serrer l'écrou de fixation. Nettoyer ou remplacer le joint torique.
Leaks from the hose under the deck.	Hose and spray head connection may be loose.	Tighten the connection between the spray head and hose.
Fuites du tuyau observées sous la plaque.	Le raccord du tuyau à la tête de vaporisation peut être desserré.	Serrez le raccord entre la tête de vaporisation et le tuyau.
Hose does not retract.	Weight is not installed in the appropriate position.	Reinstall weight (step 8).
Le tuyau ne s'escamote pas.	Le poids n'est pas dans la position Correcte.	Installez à nouveau le poids (étape 8).



Model/Modèle
BL137
BL137D

Installation / Installation

Replacement Parts / Pièces de rechange

No.	Part Name	Part No.
1	Plastic Sleeve	CTCP0683
2	Shower	ATBE0385
3	Face Plate	CTCT0168 CTWP0349
4	Locking Nut	CTWR0115 CTWT0053 CTNL0004 CTST0101
5	Cartridge	ATBA0163
6	Nut	CTKP0185
7	Cover	CTCP0330
8	Metal Handle	CTHZ0778
9	Screw	CTST0117
10	Button	CTCP0689
11	Hose	ATBP0635
12	Counter Weight	ATBQ0882

* Please indicate finish for these parts
 * Deck plate included with KIT BL137D

