

SPECIFICATIONS



ED231

Features

- Max Flow Rate : 1.2GPM(4.5L/Min) @ 60 PSI
- Fits Single Hole
- Polished Chrome(CP)
- ADA





Components

- Metal Lever Handle
- Finished Metal Body
- Ceramic Disc Cartridge
- W/O Push Pop-up Drain
- W/O Deck Plate
- Lead Free*
- Water Saving Aerator

Drain Type

- MLPOP55 – Push Style 50:50 Pop-up W/Overflow (Optional)
- MLPU4T - Push Style Brass Pop-up W/O Overflow (Optional)
- MLPUWO - Push Style Brass Pop-up W/Overflow (Optional)





Standards & Certifications

			
✓	✓	✓	✓

Available Finishes

			
✓			

Mount Type

			
✓			

Specified model meets or exceeds the following:

- ASME A112.18.1/CSA B125.1
- IAPMO/cUPC
- NSF/ANSI 372
- NSF/ANSI/CAN 61 – Sec. 9: Q≤1
- ADA
- *≤ .25% Pb

AVAILABLE MODELS

- ED231D-PU – Faucet W/Deck plate & Pop-Up
- ED231-PU – Faucet W/Pop-Up

Mainline products have been manufactured under the highest standards of quality and workmanship. That is why we offer "Limited Lifetime" warranty on the function and finish of our faucets.



Please visit www.mainlinecollection.ca for available finishes. Finish is defined by additional suffix.

Drawings

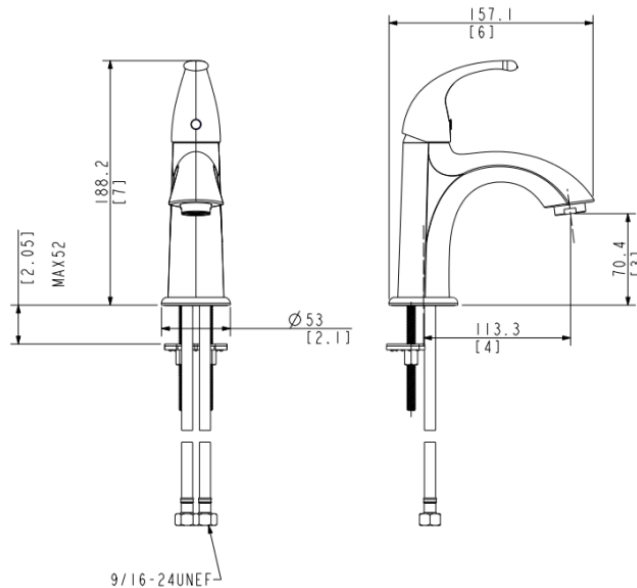

SUBMITTAL INFORMATION

Name: _____ Contractor: _____
 Location: _____ Contact #: _____
 Notes: _____

Service & Parts

Please reach out to epleservice@emcoltd.com for support/ visit mainlinecollection.ca / CANADA +1 (450) 621 5636