

### SPECIFICATIONS



ED231D-PU

#### Features

- Max Flow Rate : 1.2GPM(4.5L/Min) @ 60 PSI
- Fits Single Hole
- Polished Chrome(CP)
- ADA





#### Components

- Metal Lever Handle
- Finished Metal Body
- Ceramic Disc Cartridge
- W/ Push Pop-up Drain Assembly
- W/4" Deck Plate
- Lead Free\*
- Water Saving Aerator

#### Drain Type

- MLPOP55 – Push Style 50:50 Pop-up W/Overflow (Included)
- MLPU4T - Push Style Brass Pop-up W/O Overflow (Optional)
- MLPUWO - Push Style Brass Pop-up W/Overflow (Optional)





#### Standards & Certifications

			
✓	✓	✓	✓

#### Available Finishes

			
✓			

#### Mount Type

			
✓	✓		

Specified model meets or exceeds the following:

- ASME A112.18.1/CSA B125.1
- IAPMO/cUPC
- NSF/ANSI 372
- NSF/ANSI/CAN 61 – Sec. 9: Q≤1
- ADA
- \*≤ .25% Pb

#### AVAILABLE MODELS

- ED231-PU – Faucet W/ Pop-Up
- ED231 – Faucet Alone

Mainline products have been manufactured under the highest standards of quality and workmanship. That is why we offer "Limited Lifetime" warranty on the function and finish of our faucets.



Please visit [www.mainlinecollection.ca](http://www.mainlinecollection.ca) for available finishes. Finish is defined by additional suffix.

#### Drawings

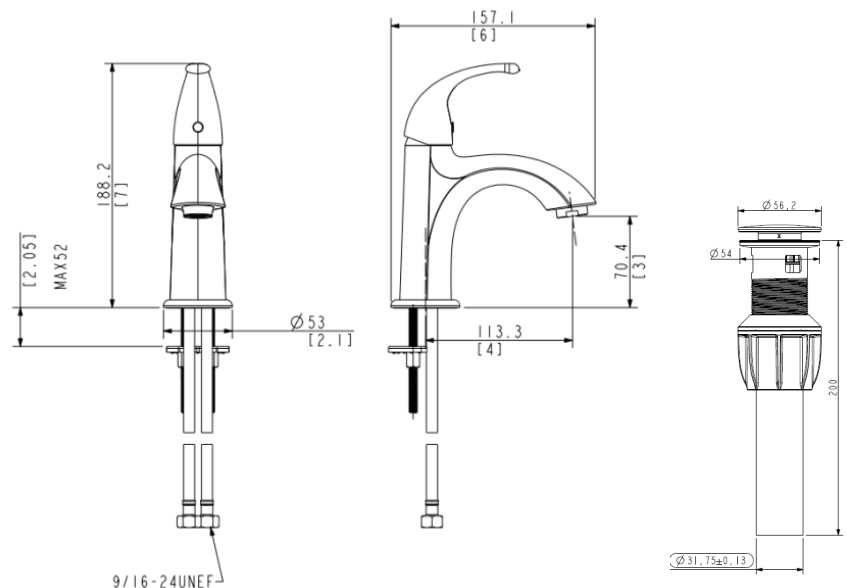

### SUBMITTAL INFORMATION

Name: \_\_\_\_\_ Contractor: \_\_\_\_\_  
 Location: \_\_\_\_\_ Contact #: \_\_\_\_\_  
 Notes: \_\_\_\_\_

#### Service & Parts

Please reach out to [epleservice@emcoltd.com](mailto:epleservice@emcoltd.com) for support/ visit [mainlinecollection.ca](http://mainlinecollection.ca) / CANADA +1 (450) 621 5636