

SPECIFICATIONS

Features

- Max Flow Rate : 1.2GPM(4.5L/Min) @ 60 PSI
- Fits 3 Hole
- Polished Chrome(CP)
- ADA

Components

- Metal Lever Handles
- Finished Metal Body
- Ceramic Disc Cartridge
- W/O Push Pop-up Drain
- Lead Free*
- Water Saving Aerator





Drain Type

- MLPOP55 – Push Style 50:50 Pop-up W/Overflow (Optional)
- MLPU4T - Push Style Brass Pop-up W/O Overflow (Optional)
- MLPUWO - Push Style Brass Pop-up W/Overflow (Optional)





ED2418



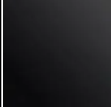

Standards & Certifications

			
✓	✓	✓	✓

Available Finishes

			
✓			

Mount Type

			
		✓	

Specified model meets or exceeds the following:

- ASME A112.18.1/CSA B125.1
- IAPMO/cUPC
- NSF/ANSI 372
- NSF/ANSI/CAN 61 – Sec. 9: Q≤1
- ADA
- *≤ .25% Pb

AVAILABLE MODELS

ED2418-PU – Faucet W/Pop –Up

Mainline products have been manufactured under the highest standards of quality and workmanship. That is why we offer "Limited Lifetime" warranty on the function and finish of our faucets.



Please visit www.mainlinecollection.ca for available finishes. Finish is defined by additional suffix.

Drawings

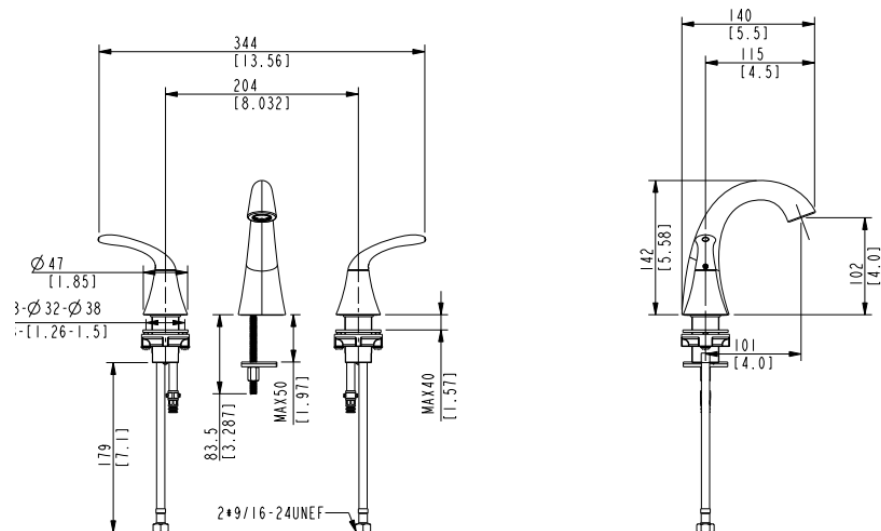

SUBMITTAL INFORMATION

Name: _____ Contractor: _____

Location: _____ Contact #: _____

Notes: _____

Service & Parts

Please reach out to epleservice@emcoltd.com for support/ visit mainlinecollection.ca / CANADA +1 (450) 621 5636