

## Installation / Installation



Towel Bar  
Porte-serviette

### Tools You Will Need / Outils dont vous aurez besoin



Drill  
Perceuse

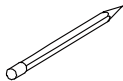

Pencil  
Crayon

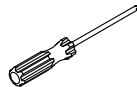

Phillips Screwdriver  
Tournevis cruciforme



Hex Wrench  
Clé hexagonale

### INSTALLATION TIPS

- The manufacturer suggests using a locally licensed plumber for installation.

### CONSIGNES DE INSTALLATION

- Le fabricant suggère de confier l'installation à un plombier qualifié pour exercer dans cette région.



**Installation / Installation**

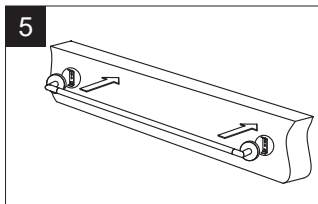
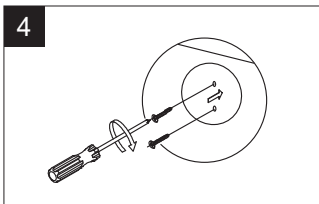
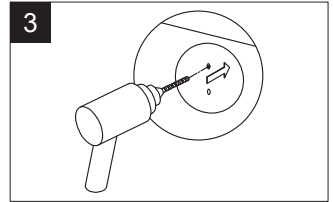
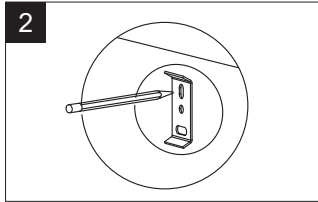
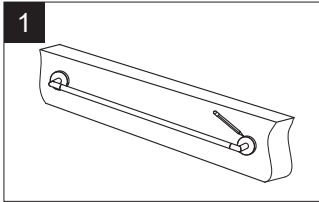

**Replacement Parts / Pièces de rechange**

No.	Description	Part No.
1	Plastic Anchors, Mounting bracket & Wood Screws / Chevilles de plastique, support de fixation & vis à bois	642014
2	Set Screw & Hex Wrench / Vis à pression & Clé hexagonale	642050

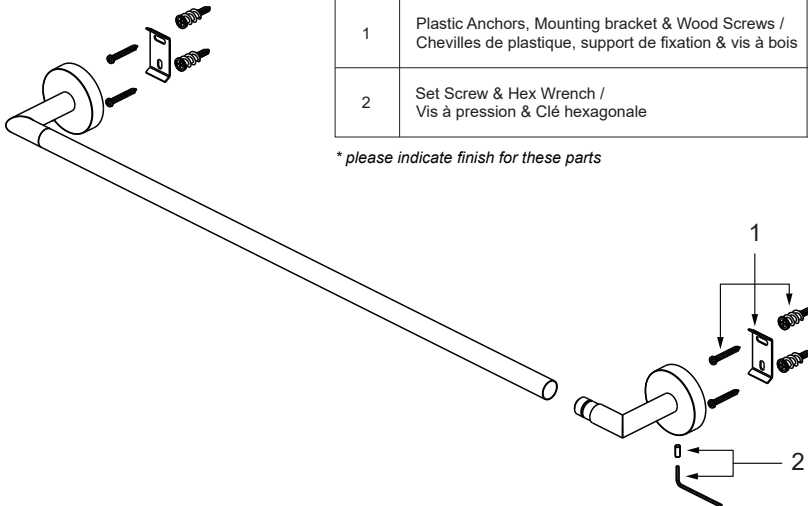

*\* please indicate finish for these parts*

Need help? Please call our customer service line at +1(450) 621-5636 for additional assistance or service. See product label for more information to visit our website: [mainlinecollection.ca](http://mainlinecollection.ca)

Besoin d'aide? Veuillez communiquer avec notre service à la clientèle au +1(450) 621-5636 pour tous renseignements ou services complémentaires. Voir l'étiquette du produit pour plus d'informations pour visiter notre site web: [mainlinecollection.ca](http://mainlinecollection.ca)

