

## SPECIFICATIONS







### Features





- Finished Metal Body
- Round Design
- Mounting Hardware included
- 1/2" 14NPT – Wall Mount
- 1/2" 14NPSM – Shower Hose
- Co-ordinates with JOVI and BLIS Suites

MLRSE

### Standards & Certifications

			
	✓		

### Available Finishes

			
✓	✓	✓	✓

Specified model meets or exceeds the following:

- ASME A112.18.1/CSA B125.1
- IAPMO/cUPC

#### AVAILABLE MODELS

N/A

Mainline products have been manufactured under the highest standards of quality and workmanship. That is why we offer "Limited 5 Year" warranty on the function and finish of our faucets.



Please visit [www.mainlinecollection.ca](http://www.mainlinecollection.ca) for available finishes. Finish is defined by additional suffix.

### Drawings

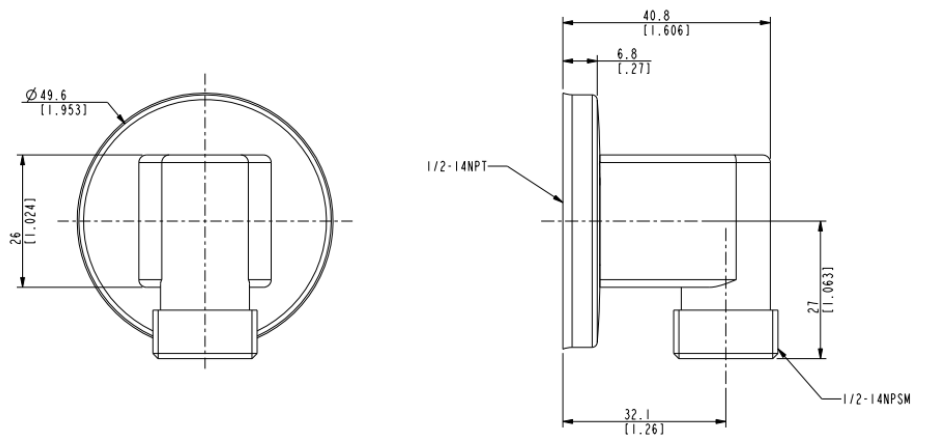

## SUBMITTAL INFORMATION

Name: \_\_\_\_\_ Contractor: \_\_\_\_\_

Location: \_\_\_\_\_ Contact #: \_\_\_\_\_

Notes: \_\_\_\_\_

#### Service & Parts

Please reach out to [epleservice@emcoltd.com](mailto:epleservice@emcoltd.com) for support/ visit [mainlinecollection.ca](http://mainlinecollection.ca) / CANADA +1 (450) 621 5636