







## SPECIFICATIONS

### Features

- Tub Spout
- Die-Cast
- 1/2"-14NPT/SLIPFIT
- CUPC Certified

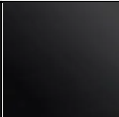

MLRSPT

Standards & Certifications				Available Finishes			
							
	✓			✓	✓	✓	✓

Specified model meets or exceeds the following:

- ASME A112.18.1/CSA B125.1
- IAPMO/cUPC

#### AVAILABLE MODELS

MLRDSPT – Diverter Spout

Mainline products have been manufactured under the highest standards of quality and workmanship. That is why we offer "Limited Lifetime" warranty on the function and finish of our faucets.



Please visit [www.mainlinecollection.ca](http://www.mainlinecollection.ca) for available finishes. Finish is defined by additional suffix.

### Drawings

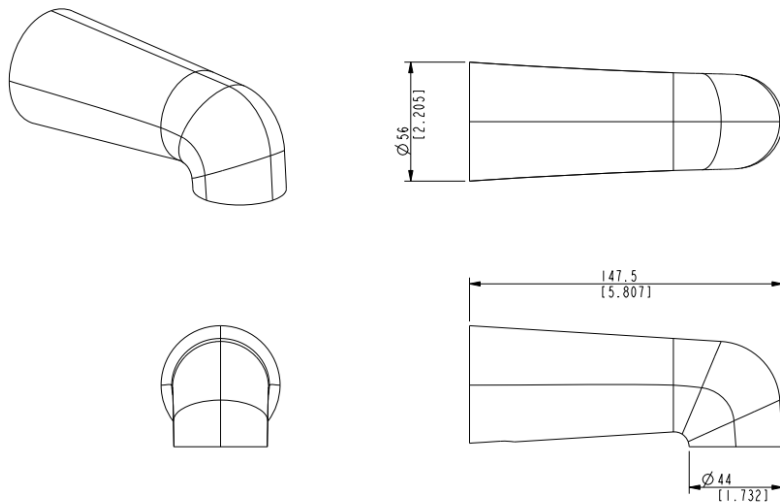

## SUBMITTAL INFORMATION

Name: \_\_\_\_\_ Contractor: \_\_\_\_\_  
 Location: \_\_\_\_\_ Contact #: \_\_\_\_\_  
 Notes: \_\_\_\_\_

#### Service & Parts

Please reach out to [epleservice@emcoltd.com](mailto:epleservice@emcoltd.com) for support/ visit [mainlinecollection.ca](http://mainlinecollection.ca) / CANADA +1 (450) 621 5636