

SPECIFICATIONS

Features









- 8" Shower Arm for Wall Mount Application
- Finished Metal Body
- W/ Round Flange
- 1/2" -14 NPT Connection – Wall Side
- 1/2" – 14 NPSM Connection – Shower Side



Kit Components

- Round Shower Flange – MLRSF
- 8" Shower Arm – ML8SA

RO8SA

Standards & Certifications				Available Finishes			
							
	✓			✓	✓		✓

Specified model meets or exceeds the following:

- ASME A112.18.1/CSA B125.1
- IAPMO/cUPC

AVAILABLE FORMATS

Multiple Kit Formats Available
Visit mainlinecollection.ca

Mainline products have been manufactured under the highest standards of quality and workmanship. That is why we offer "Limited 5 Year" warranty on the function and finish of our accessories.



Please visit www.mainlinecollection.ca for available finishes. Finish is defined by additional suffix.

Drawings

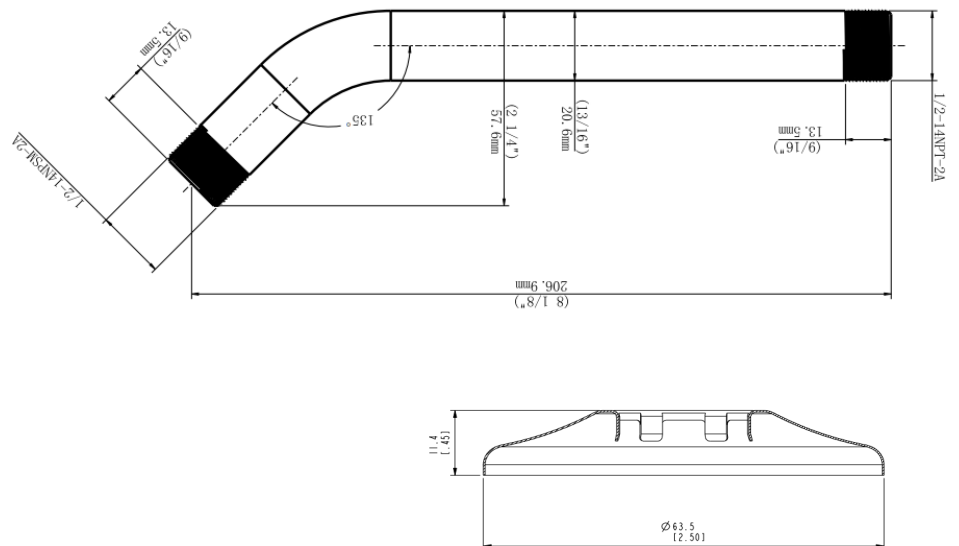

SUBMITTAL INFORMATION

Name: _____ Contractor: _____
 Location: _____ Contact #: _____
 Notes: _____

Service & Parts

Please reach out to epleservice@emcoltd.com for support/ visit mainlinecollection.ca / CANADA +1 (450) 621 5636